

HX10E 1150X680

HIGH LIFT PALLET TRUCK - ELECTRIC



HX10 E

The HX10E scissor Lift makes possible an easy and light lifting to a height of 800 mm thanks to the reliable electric motor and to the powerful battery. When lifted, it becomes a practical work platform, which is suitable for places such as machine workshops. This pallet truck is also able to carry out the support function and material supply along the assembly and production lines.



TILLER

The handle offers an ergonomic tiller and an electric switch for lifting and lowering operations. The tiller design ensures operator comfort on pushing operations.



SAFETY AND EFFICIENCY

The emergency pushbutton with the function of battery cut-off switch (isolator) and the off-load valve allowing a smoother lowering of the load are some of the devices that make the work safer and more efficient.



CONFIGURATION

STANDARD: Rubber steering wheels and polyurethane rollers



Complete with 12V battery and external battery charger



Descriere

1.1 Producător			LIFTER
1.3 Comandă			Manual
1.4 Poziție operare			Pedestru
1.5 Capacitate maximă	Q	Kg	1000
1.6 Distanța la centrul de aplicare al sarcinii	c	mm	600
1.8 Sarcina de la osie la capătul furcilor	x	mm	993
1.9 Ampatament	y	mm	1231

Greutăți

2.1 Greutate de operare (acumulator inclus)		Kg	146
2.2 Sarcină osie, încărcare pe spate		Kg	710
2.2 Sarcină osie, încărcare pe față		Kg	436
2.3 Sarcină osie, liber față		Kg	118
2.3 Sarcină osie, liber spate		Kg	28

Cauciucuri/Șasiuri

3.1 Cauciucuri: roți direcție			CAUCIUC
3.1 Cauciucuri: transportoare cu role			POLY.I.
3.2 Mărime cauciuc: roți direcție - Lățime		mm	50
3.2 Mărime cauciuc: roți direcție - Diametru		mm	200
3.3 Mărime cauciuc: transportoare cu role - Diametru		mm	80
3.3 Mărime cauciuc: transportoare cu role - Lățime		mm	50
3.5 Dimensiune cauciuc: roti spate		nr	2
3.6 Ecartament, față	b10	mm	155
3.7 Ecartament, spate	b11	mm	587

Dimensiuni

4.4 Înălțime stivuitor	h3	mm	715
4.9 Height of tiller in drive position min	h14	mm	915
4.9 Înălțime manetă în poziția de deplasare, max	h14	mm	1300
4.15 Înălțime, coborât	h13	mm	85
4.19 Lungime globală	l1	mm	1690
4.20 Distanța până la suprafața frontală a furcilor	l2	mm	540
4.21 Lățime globală	b1	mm	680
4.22 Dimensiuni furcă - grosime	s	mm	48
4.22 Dimensiuni furcă - Lățime	e	mm	160
4.22 Dimensiuni furcă - Lungime	l	mm	1150
4.25 Distanța între furci	b5	mm	680
4.32 Gardă la sol și mijloc ampatament	m2	mm	21
4.34 Lățime culoar	Ast	mm	2193
4.35 Rază de virare	Wa	mm	1543

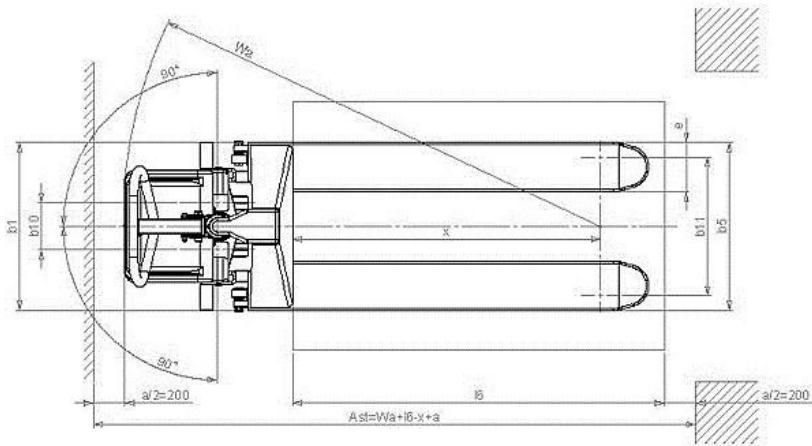
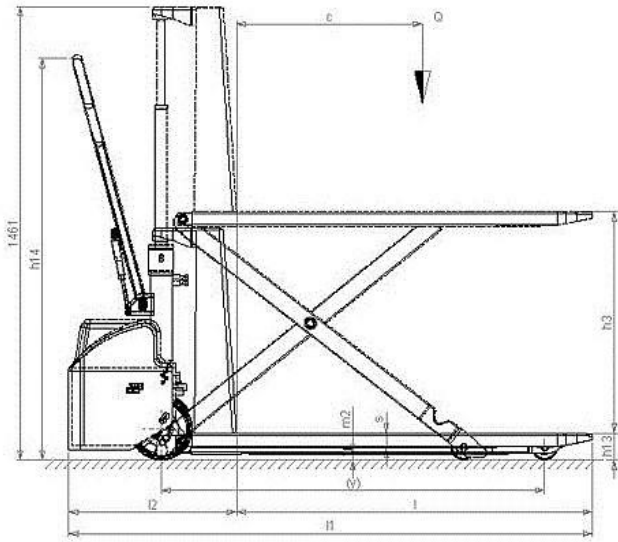

The information is aligned with the Data file at the time of download. Printed on 24/02/2020 (ID 482)

©2019 | PR INDUSTRIAL s.r.l. | All rights reserved | Image shown may not reflect actual package. Specifications subject to change without notice

